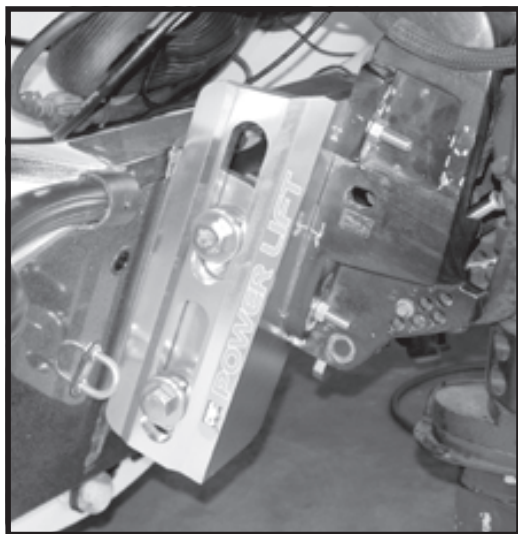
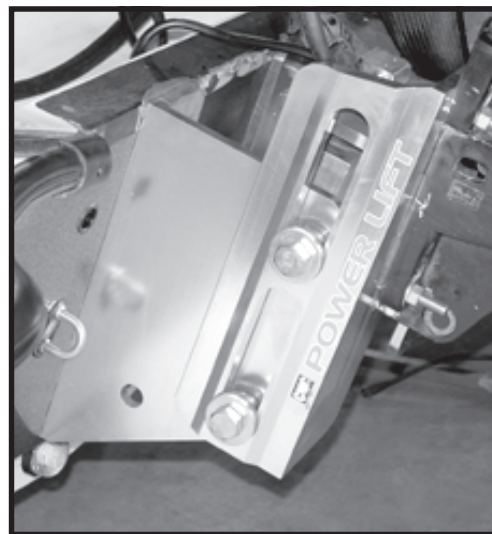


# OWNER'S MANUAL



5-1/2" SET-BACK



10" SET-BACK

## THE #1 TRANSOM JACK

### FOREWORD

Thank you for choosing a CMC product. All of us at CMC hope you receive the maximum performance from your outboard motor through use of your new CMC Power-Lift®. This manual is designed to aid in installation, operation and maintenance of your Power-Lift®. Each part of the CMC Power-Lift® is precision machined from the highest quality material to insure many years of trouble free service.

### CONTENTS

Foreword .....	Outside Front Cover
Installation .....	Inside Front Cover
Warranty Card .....	Centerfold
Servicing.....	Page 6
Actuator Removal .....	Page 7
Adjustments and Driving .....	Page 8
Parts List .....	Inside Back Cover
Troubleshooting.....	Inside Back Cover
Warranty .....	Outside Back Cover

# COOK MANUFACTURING CORPORATION



© COPYRIGHT - 2007 Part #4001 REVISION 22

U. S. Patent 4,482,330

## INSTALLATION

The CMC Power-Lift has been predrilled to fit all standard outboard motor mounting hole configurations. If your boat and motor is not drilled to these specifications, some drilling may be necessary. Consult an installation manual for your outboard for proper mounting dimensions. Be sure to use at least four 1/2" diameter stainless steel bolts and nuts for mounting the Power-Lift to your boat.

For proper installation the following items should be included in your Power-Lift box:

### HYDRAULIC UNIT

(Item Numbers - 65001, 65002, 65007, 65008, 65201, 61001, 61002 61007 and 61008)

1. One Hydraulic Power-Lift unit
2. One wire assembly
3. One Power-Lift position indicator gauge (65001, 65201, 61001, 61007, 61008, 65007, 65008)
4. Four 1/2" -13 x 3 stainless steel hex head cap screws
5. Four 1/2" -13 stainless steel hex nuts
6. Four 1/2" stainless steel lock washers
7. Four 1/2" stainless steel flat washers
8. One up down toggle switch

Step 1: Consult outboard motor manual or dealer for proper outboard motor lifting procedures. You will need to lift the motor in some fashion with a lifting device rated at the proper lifting capacity.

Step 2: Attach lifting device to motor making sure motor is supported safely.

Step 3: Remove the four nuts that presently mount your motor to the transom of your boat.

Step 4: Swing the motor away from the boat taking care not to damage any wires or cables. (Fig. 1)

Most cables have plenty of extra length to allow enough movement to install Power-Lift without disconnecting them, although on some models disconnecting may be necessary.

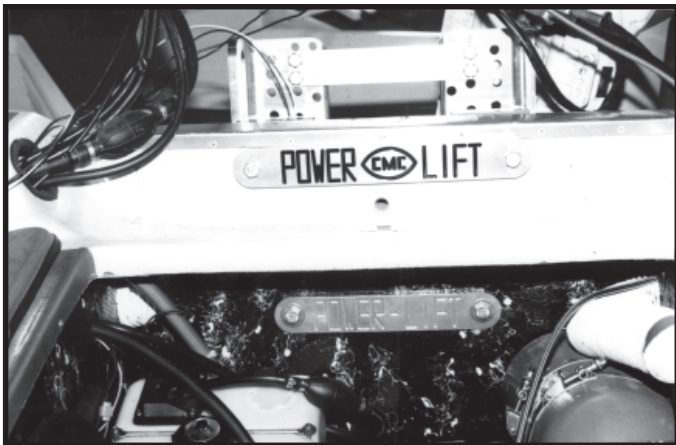


FIG. 2

### MANUAL UNIT

(Item Numbers - 65012, 65212 and 61012)

1. One Manual Power-Lift unit
2. Four 1/2" -13 x 3 stainless steel hex head cap screws
3. Four 1/2" -13 stainless steel hex nuts
4. Four 1/2" stainless steel lock washers
5. Four 1/2" stainless steel flat washers

### SET-BACK UNIT

(Item Numbers - 55012, 40012, 70012 and 90012)

1. One Set-Back unit
2. Four 1/2" -13 x 3 stainless steel hex head cap screws
3. Four 1/2" -13 stainless steel hex nuts
4. Four 1/2" stainless steel lock washers
5. Four 1/2" stainless steel flat washers

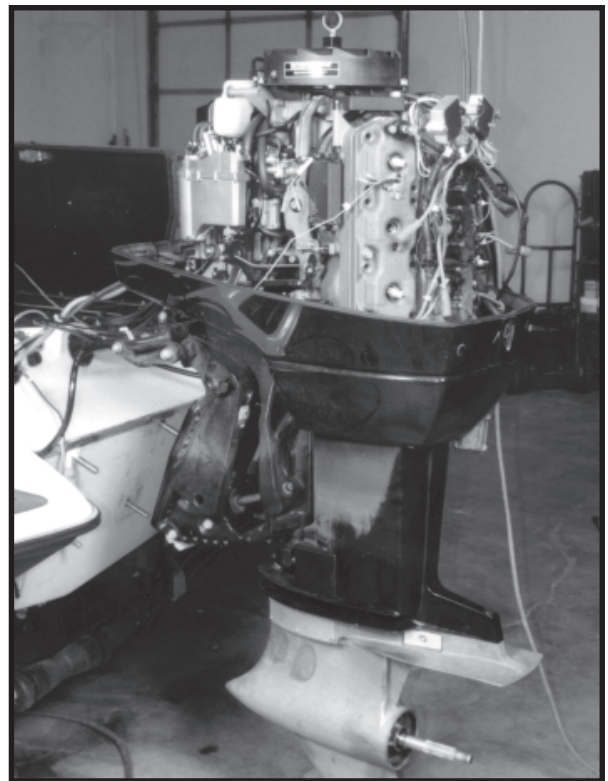


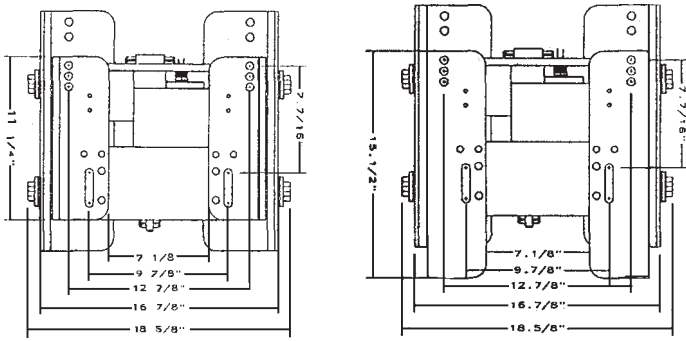
FIG. 1

We recommend using transom washer plates if you plan to mount a V6 or larger motor. The CMC transom washer plates (Fig. 2) can eliminate embedding of bolt heads into the transom by more evenly distributing loads on high performance engines.

The figures below show the transom view and the motor view of the Hydraulic Power-Lift, Manual Power Lift and Set-Back Plate. (Fig. 3, 4, 5, 6, 7, 8 and 9). All three should be mounted the same way. The transom view (small side) to the transom and the motor view (large side) to the motor.

**TRANSOM VIEW  
HYDRAULIC POWER-LIFT**

**FIG. 3**

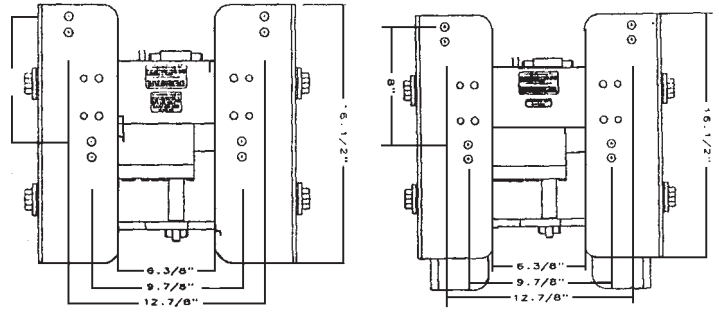


5-1/2" SET-BACK

10" SET-BACK

**MOTOR VIEW  
HYDRAULIC POWER-LIFT**

**FIG. 4**

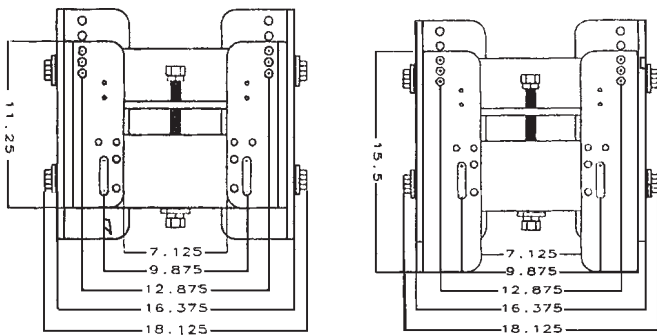


5-1/2" SET-BACK

10" SET-BACK

**TRANSOM VIEW  
MANUAL POWER-LIFT**

**FIG. 5**

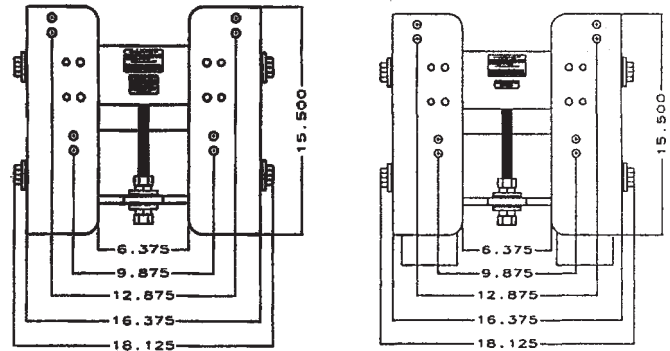


5-1/2" SET-BACK

10" SET-BACK

**MOTOR VIEW  
MANUAL POWER-LIFT**

**FIG. 6**

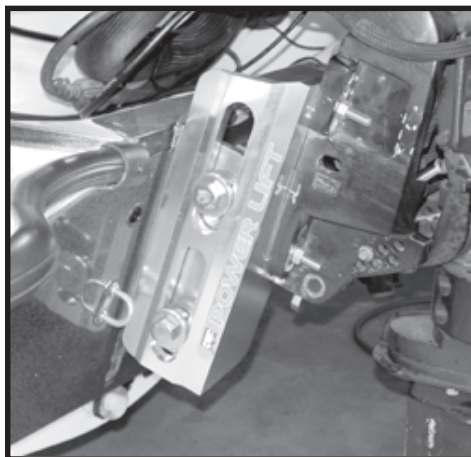
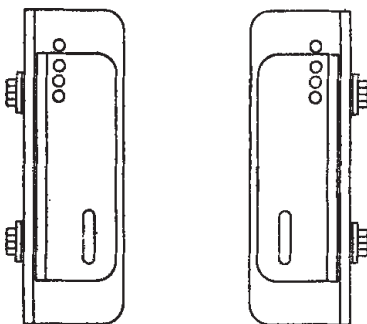


5-1/2" SET-BACK

10" SET-BACK

**TRANSOM VIEW  
SET-BACK**

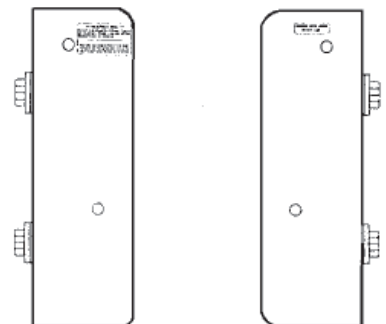
**FIG. 7**



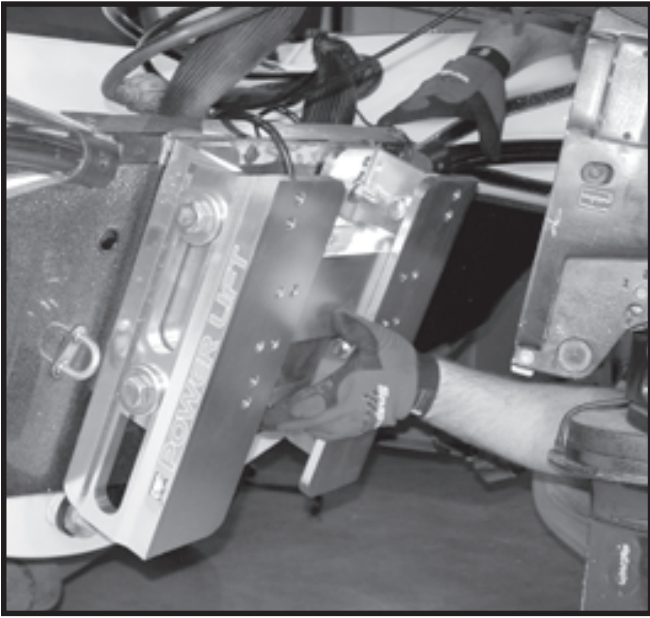
**FIG. 9**

**MOTOR VIEW  
SET-BACK**

**FIG. 8**



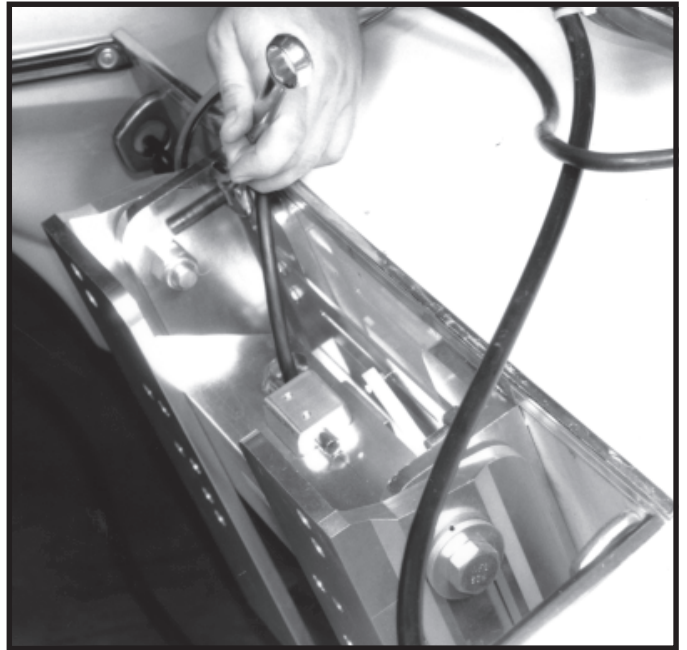




**FIG. 10**

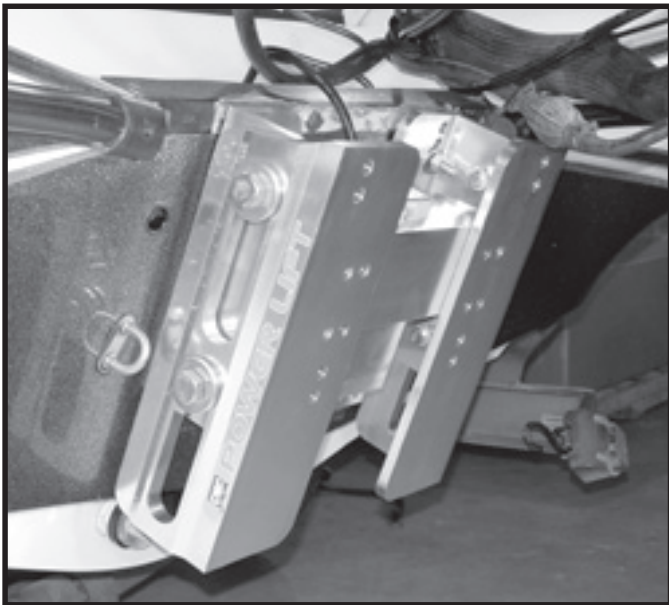
Step 5: Mount the Power-Lift unit on the boat transom by use of four predrilled holes in the transom of boat. (Fig. 10)

**NOTE:** Before mounting the Power-Lift, determine the basic setting for the motor. Remember there is 5" of stroke on the Power-Lift. If you want to run at full speed in rough water or have more pulling power it would be best to mount the Power-Lift where the cavitation plate of your motor is around 2" below the bottom of the boat when the Power-Lift is adjusted all the way down. If you are planning to run mostly in shallow water and/or your primary objective is more top end speed, mount the Power-Lift where the cavitation plate of your motor is about even with the bottom of the boat when the Power-Lift is adjusted all the way down. The three sets of mounting holes on the transom side of the Power-Lift will allow the Power-Lift to be set at different heights. (Fig. 11)



**FIG. 11**

Step 6: Fasten the unit to the transom with the nuts previously used for the motor, making sure to use a flat washer and a lock washer before the nut. If the bolts in the transom are protruding too far into the Power Lift structure to cause a clearance problem, then these bolts must be redirected from the inside of the Power-Lift through the transom. (Fig. 12)



**FIG. 12**

**NOTE:** For extreme high performance applications when the motor is raised to extreme heights, we recommend a water pressure gauge be installed for the motor's protection. This will allow for constant monitoring of the cooling system.

## STANDARD MOUNTING

(Hydraulic, Manual and Set-Back)

All Evinrude/Johnson - Down through 50 h.p.

All Yamaha - Down through 50 h.p.

All 1980 and Newer V-6 Mercury/Mariner

All Suzuki- Down through 115 h.p.

Upper and Lower B.I.A. Standard Mounting (Fig. 13)

**NOTE:** If your motor does not have the standard B.I.A. hole pattern then drilling will be necessary.

Step 7: If your motor has the B.I.A. Standard Mounting holes, mount your motor to the Power-Lift using the four predrilled upper **or** lower mounting (see Fig. 13) and the 1/2"-13 x 3 bolt, 1/2" - 13 hex nuts, flat and lock washers furnished. (Fig. 14)

**NOTE:** To insure proper internal clearance insert bolt with threads protruding toward motor. Make sure all nuts and bolts are tight. These should be rechecked frequently for correct tightness. Mount motor high enough on Power-Lift for proper clearance of the dual steering when motor is tilted. Also, when tilting motor all the way up (trailing etc.) make sure the Power-Lift is in the up position for proper clearance of the motor cowling and transom.

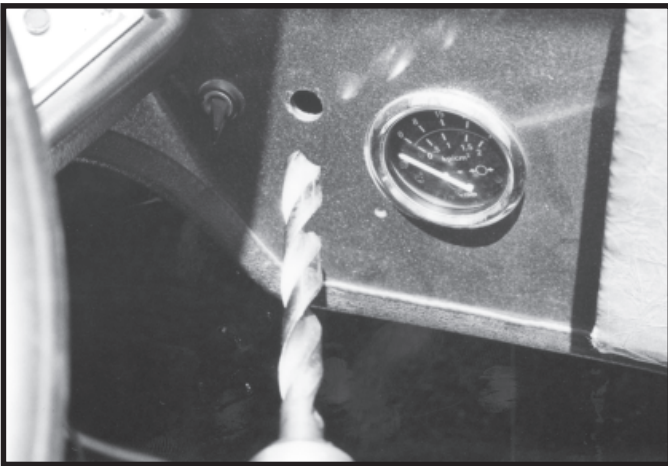


FIG. 15

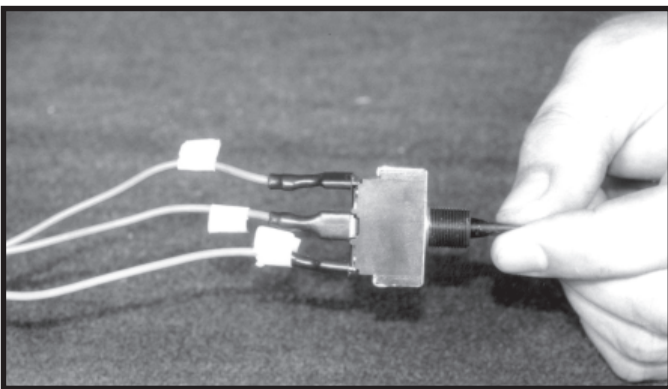


FIG. 16

## MOTOR VIEW

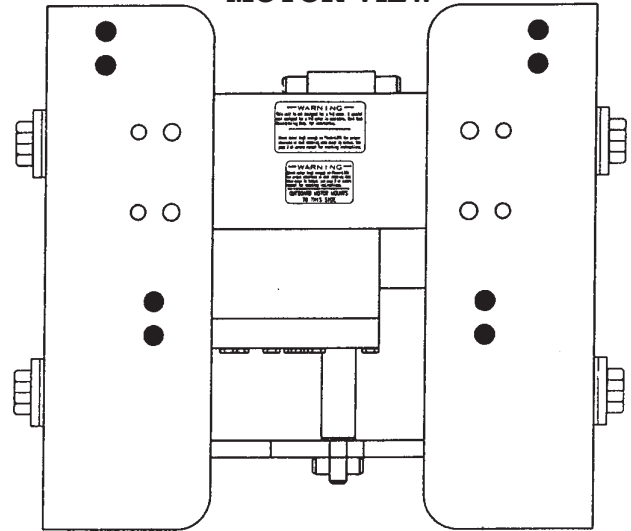


FIG. 13

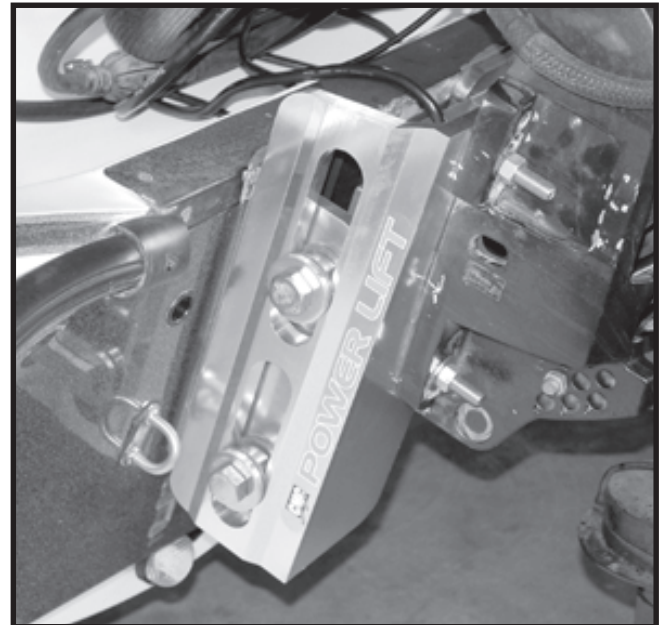


FIG. 14

Step 8: Find a good location for the up-down toggle switch. This switch should be located for easy access while operating throttle. Use 1/2" drill to drill hole at location taking care not to damage wires or brackets. (Fig. 15)

Step 9: Locate the wires on wire assembly;

- (1.) Labeled **up**;
- (2.) One labeled **down**;
- (3.) One labeled **12V**.

Locate the keyway on the toggle switch. Position the switch so that the keyway on the switch is up. Connect the **up** wire to the top post. Connect the **12V** wire to the center post. Connect the **down** wire to the bottom post. (Fig. 16)



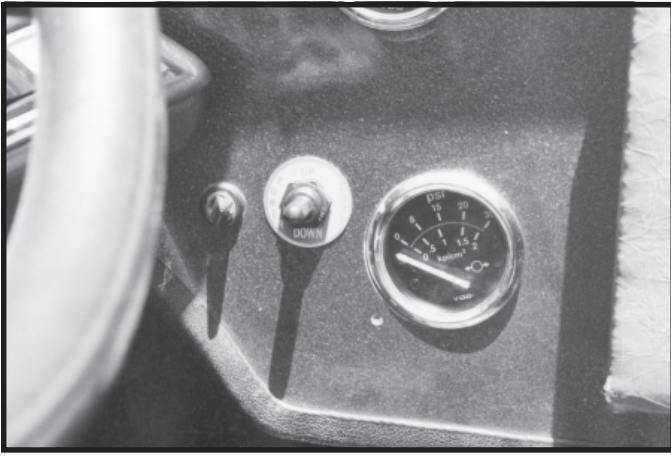


FIG. 17

Step 10: Push the toggle switch through the 1/2" hole that you previously drilled. Place the up-down switch plate and rubber boot with nut on the switch. (Fig. 17)

Step 11: Connect the 2-wire male connector from the hydraulic power unit to the female 2-wire connector at the end of the wire assembly. (Fig. 18)

**NOTE:** Route the electrical cordset coming from the actuator so that if the motor is tilted when the Power-Lift is all of the way down nothing can cut into it.

Find a dry location for the two 40 amp relays and secure them there.

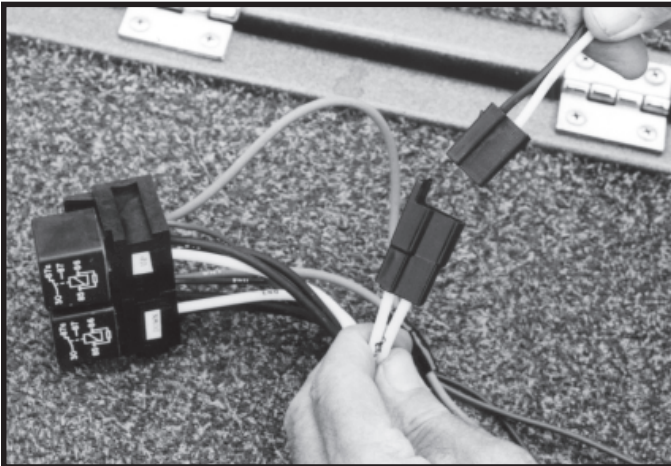


FIG. 18

Step 12: Connect the ring terminal labeled **pos** to the positive battery terminal and connect the ring terminal labeled **neg** to the negative battery terminal. (Fig. 19)

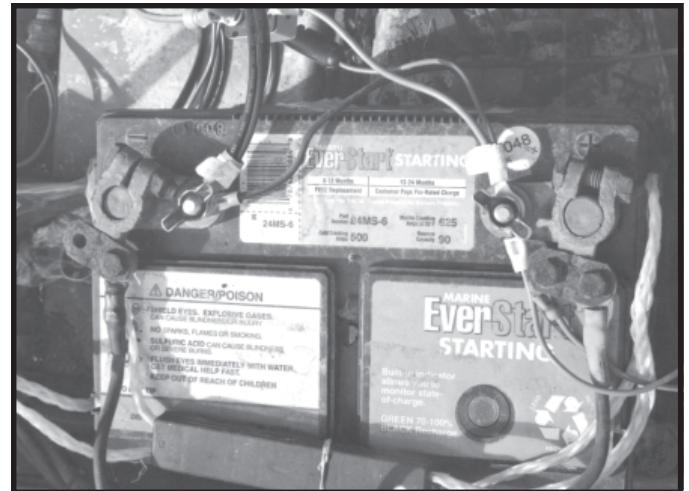


FIG. 19

This will make the Power-Lift operational. Try the toggle switch **up** to make sure it runs up and **down** to make sure it runs down.

**NOTE:** If your boat is used in a corrosive environment such as saltwater and you cannot locate a dry place for the relays, you can secure the relays inside the cowling of your engine. Instead of connecting the positive and negative ring terminals of the wire assembly to the battery, connect to the starter where the positive and negative leads from the battery are attached.

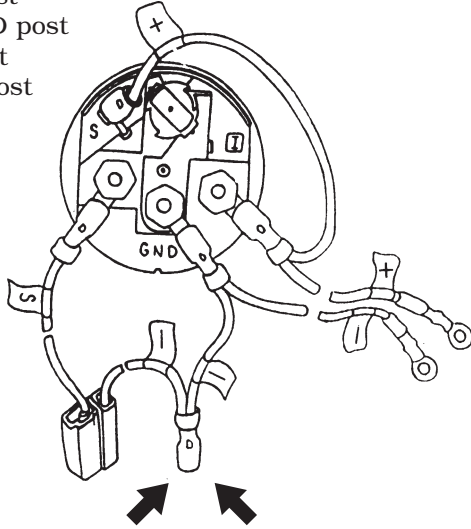
Step 13: If the Power-Lift was purchased with a position indicator gauge, find a good location for it. This gauge is used to determine the height of the motor without looking back, allowing the driver to maintain a forward view at all times. Cut a 2 1/8" hole in the location chosen. Make sure not to cut into any wiring or other brackets. (Fig. 20)



FIG. 20

Step 14: The gauge wire assembly consist of black and white wires coming from a male connection. The other end of the black wire will have a red pigtail wire and black and red wires with ring terminals. Pull the white wire labeled S, and the black wire labeled -, and red wires labeled + through the gauge hole you cut. Connect the wires to the gauge as follows:

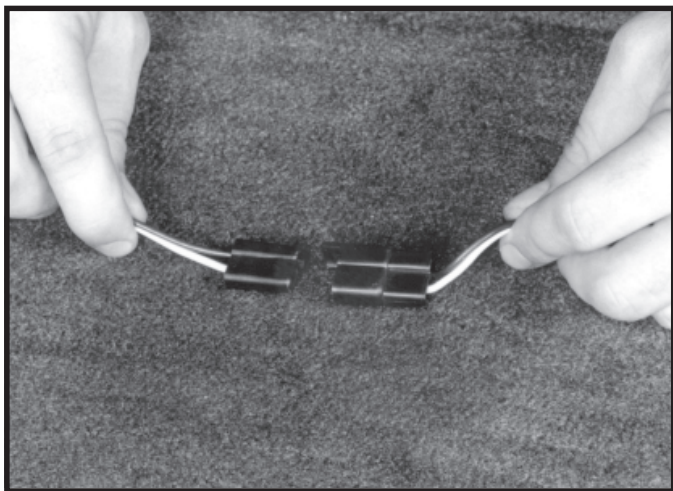
- S terminal to S post
- terminal to GND post
- + terminal to I post
- + pigtail to lamp post



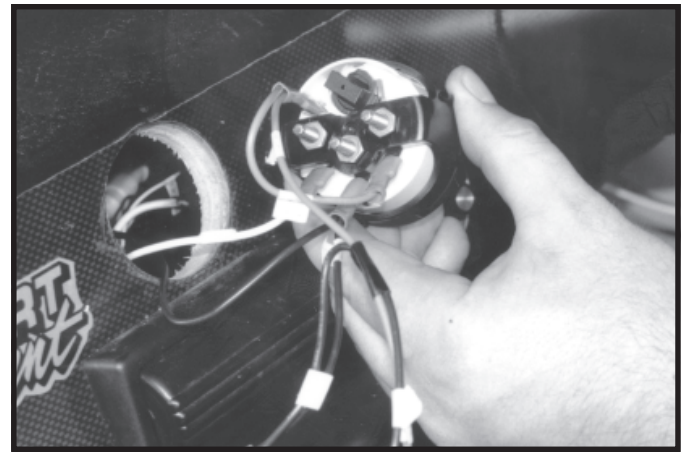
*This extra pigtail will not be used on the GND (-) wire.*

**NOTE:** The clamp bracket should be attached to the gauge before the above wires are connected. (Fig. 21) The figure above is shown without the clamp bracket to make it easier for you to see where the wires connect.

Push the gauge into the hole and clamp into the hole using the clamp and nuts furnished with the gauge. (Fig. 22)



**FIG. 23**



**FIG. 21**



**FIG. 22**

Step 15: Next, locate the red wire with the small ring terminal and the black wire with the small ring terminal. These wires supply 12 volt power to the gauge, so they should be connected to the ignition switch or tapped into wires already connected to the switch using wire tap connectors. This will allow you to use the gauge only when the motor is in operation. The red terminal is for + 12 volts DC. The black terminal is for ground.

Step 16: Locate the 2-wire female connector at the other end of the gauge wire assembly and the 2-wire female connector from the gauge sending unit and make connection (Fig. 23). Now turn on the ignition switch, check lamp illumination in gauge. The light should be on. With the ignition switch on, run the Power-Lift up and down. The gauge needle should indicate up and down movement. If these things operate correctly your Power-Lift is ready for operation.



## SERVICING

Your CMC Power-Lift is operated with a hydraulic actuator which is located inside the unit. It is filled with the correct amount of fluid and tested at the factory. If it becomes necessary to add fluid to the actuator, use #2216 Mystic or equivalent, SAE 20 or 30 non detergent oil. The procedure for adding fluid and bleeding the system is as follows:

1. Run the Power-Lift until the actuator rod is completely extended or the Power-Lift is all the way up. If the Power-Lift is low on fluid and will not extend, remove the 1/8" stainless socket **filler** plug with a 3/16" hex key wrench (Fig. 24), and add fluid until rod can completely extend or the Power-Lift is all the way up.
2. With the **filler** plug removed, run the Power-Lift until the actuator rod is completely retracted or the Power-Lift is all the way down. Let all the air bubbles run out of the **filler** hole until air in the fluid stops.
3. Run the Power-Lift until the actuator rod is 3" extended (Fig. 25), then remove the 1/8" stainless socket **level** plug, (Fig. 26)
4. Add fluid through the **filler** hole until fluid begins to run out of the level hole (Fig. 27). You can use #2216 Mystic or equivalent, SAE 20 or 30 non-detergent oil, or Tilt and Trim fluid.
5. Replace the **level** plug (Fig. 28).
6. Run Power-Lift until actuator rod is completely extended or Power-Lift is all the way up (Fig. 29). Replace the **filler** plug.

If preferred, the above procedure can be executed with the actuator completely removed. Please see the next page for the procedure for removal of the actuator.



FIG. 24

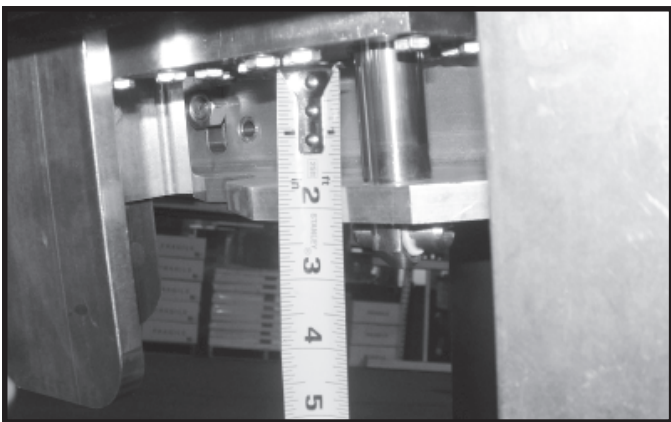


FIG. 25

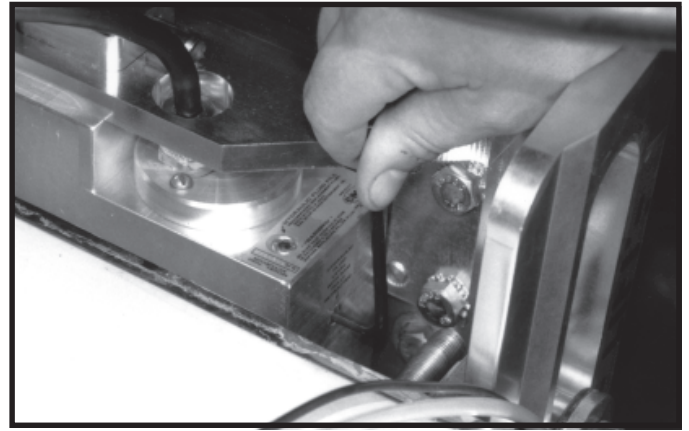


FIG. 26

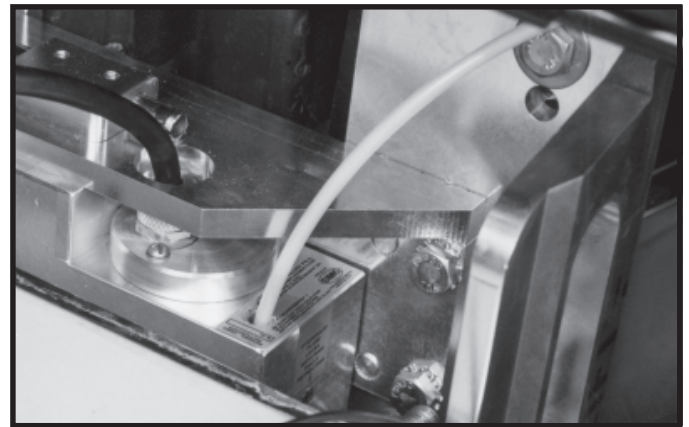


FIG. 27

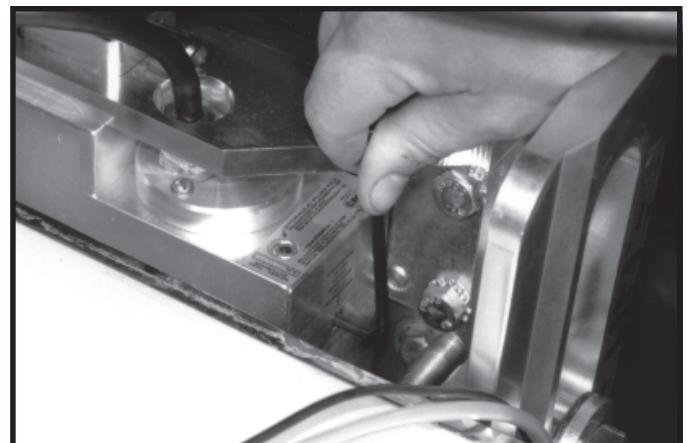


FIG. 28



FIG. 29



## ACTUATOR REMOVAL

To remove the actuator from the Power-Lift, raise the Power-Lift all the way up and tighten the four bolts on the sides to 100 foot pounds each to hold it in place (Fig. 30). There are two actuator spring pins that attach to the structure of the Power-Lift. One spring pin is located at the top of the actuator and the other is located at the bottom of the ram. With a 1/2" to 7/16" diameter driver bar (driver bar available from CMC) drive the spring pin at the bottom of the ram out (Fig. 31). Next, insert the driver bar through the slot at the top of the Power-Lift to the spring pin at the top of the actuator and drive the pin out (Fig. 32). Remove the actuator from the bottom of the Power Lift (Fig. 33).

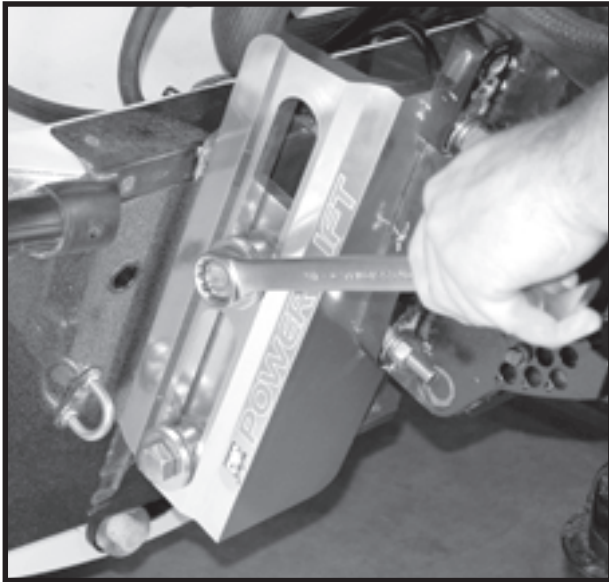


FIG. 30

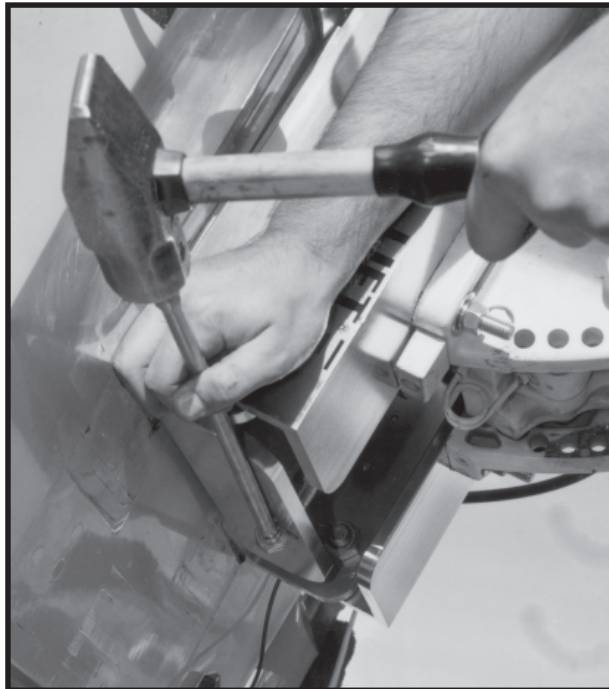


FIG. 31



FIG. 32



FIG. 33

## EMERGENCY RELIEF VALVE

Your Power-Lift actuator features a emergency relief valve that will allow you to manually raise or lower the Power-Lift if it becomes necessary due to power loss or actuator malfunction. This emergency relief valve is a 1/4" hex screw head located at the bottom of the actuator toward the port side (Fig. 34). Gradually turn the relief valve counter clockwise 1/2 to 1 full turn (**NO MORE THAN 1 FULL TURN**). This will allow you to manually raise or lower the Power-Lift.

**CAUTION: IF THE POWER-LIFT IS IN THE UP POSITION WHEN IT BECOMES NECESSARY TO RELIEVE THE PRESSURE IN THE SYSTEM, FIRST SUPPORT THE UNIT WITH A FLOOR JACK OR HOIST. THEN RELIEVE THE PRESSURE AND SLOWLY LOWER THE UNIT WITH THE FLOOR JACK OR HOIST. EXERCISE CAUTION TO AVOID INJURY.**



FIG. 34

## ADJUSTMENTS

Your CMC Power-Lift is equipped with aluminum-bronze alloy bearings and Nylatron G. S. M. thrust guides. These are adjusted at the factory and should run at this setting for many hours of operation. The thrust guides are furnished to eliminate any side movement "shimmy" of the Power-Lift and these can be adjusted. This procedure is as follows:

(1.) With your fingers try to rotate the large Nylatron guides. If the guides will rotate easily they do not require adjustment. If you can rotate them easily by "spinning" them, adjustment may be necessary.

(2.) Loosen all four jam nuts on the inside of the bracket. These jam nuts hold the stainless steel pin and the adjustment in place.

(3.) Turn the hex head of the pin clockwise to tighten the guide and counter clockwise to loosen the guide. **CAUTION: Extra care should be used not to over tighten. The guide should be adjusted to rotate with your fingers, easily, but not so loose that you can "spin" them. Some "feel" is required here. Proper**

**guide adjustment is critical for satisfactory performance of the Power-Lift.** Since the Power-Lift is equipped with long wearing aluminum-bronze alloy bearings and Nylatron thrust guides, the adjustment should not be needed frequently, perhaps never.

(4.) Re-tighten the four jam nuts on the inside of the bracket. Recheck guide rotation.

## DRIVING

Driving an outboard at high speeds takes careful thought and handling. Start at low speeds and work your way up to higher speeds. As you raise your motor with the Power-Lift you will notice a torque on your steering wheel. This is caused by the propeller operating at a higher position in the water.

Hold the steering wheel firmly as you raise or lower the motor. In case of high horsepower motors you may invest in a foot switch for the Power-Lift. This will allow you to keep both hands on the steering wheel while raising and lowering your motor.

## OPERATION OF THE MANUAL POWER-LIFT

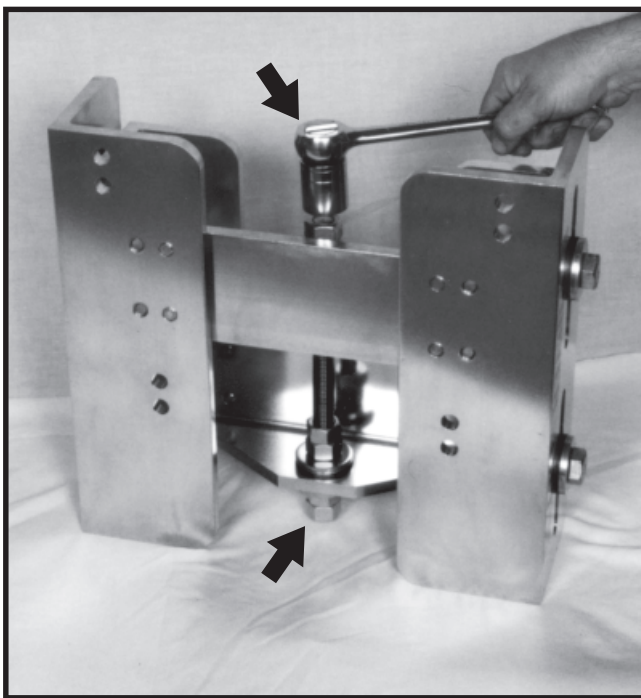


FIG. 35

The maximum engine height is determined by the hole slot and engine water pressure at top end speed. If the engine is adjusted too high, there will be a loss of water pressure to the engine at top end speed and/or the prop will cavitate coming out of the hole. A water pressure gauge is recommended on high performance applications when the motor is raised to extreme heights. This will allow for constant monitoring of the motor's cooling system.

### HEIGHT ADJUSTMENT FOR THE MANUAL UNIT (MODEL ML-65, ML-65SS AND ML-65-10)

Refer to Figs. 5 & 6 page 1 for mounting. Mount the transom view to the transom and the motor view to the motor. To adjust the manual Power-Lift simply loosen the 4 clamp bolts on the sides using a 1-1/8" wrench. Using the same wrench, turn the 3/4" nut at the top or the bottom of the Power-Lift to raise or lower the motor (See arrows Fig. 35). Then tighten the 4 clamp bolts to hold it in position. The clamp bolts on all of our manual units should be tightened to 100 foot pounds each.

### HEIGHT ADJUSTMENT FOR THE SET-BACK UNIT (TWO PIECE MANUAL)

To make the height adjustment for the Set-Back (two-piece manual) loosen the 4 clamp bolts on the sides. Then raise your motor with a hoist or floor jack to the desired height. Tighten the 4 clamp bolts to 100 foot pounds each to hold the position in place.

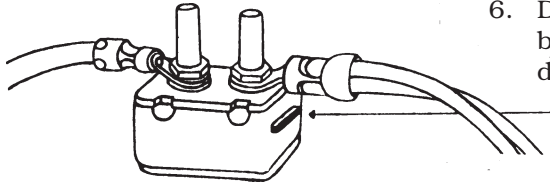
Since you can not make height adjustment while underway with a manually adjustable unit, a compromising position must be obtained between hole shot and top end speed. Low enough to come out of the hole without slipping and high enough for more top end speed without loss of water pressure to the engine. The set back on the Power-Lift is 5-1/2 inches. This will put the prop in "cleaner" water thus giving the prop a better "bite" and eliminate prop slippage at a higher setting than can be made at the transom.

# TROUBLESHOOTING

If problems should occur, follow the check list below step by step. This should eliminate any simple problems that might arise.

**PROBLEM:**

Will not run in either direction



**CIRCUIT BREAKER RESET BUTTON**

1. Check for dead battery
2. Reset the circuit breaker at + battery terminal
3. Check continuity through toggle switch
4. Check wire continuity from switch to connector
5. Check for 12 volts at toggle switch, wire labeled +
6. Disconnect the actuator cordset from the relay wire assembly and jump the actuator directly to the battery. If it doesn't run, replace the actuator.

Will not run in one direction

1. Check toggle switch
2. Check wire continuity from toggle switch to connector

Actuator runs but unit does not move up or down

1. Check hydraulic fluid level.

Unit at up position leaks down to bottom

1. Run unit up and down several times. Could have debris in check valve. If this does not correct the problem, replace actuator.

Unit at up position will not come down

1. Make sure there is no foreign object binding the unit.
2. Make sure the thrust guides are not too tight. See "adjustments" page 8. If none of the above, replace actuator.

Unit will not go up under power or goes up very, slowly while not under power

1. Check with ammeter at + wire to see if registering 50 - 60 amps when unit is run to top and is "bogging" down. (unit will pull 25 - 40 amps during up and down motion)
2. If a smaller gauge wire has been spliced into wire harness, this could be the cause.
3. Check with voltmeter to see if getting 12 volt from battery. Also check it as the Power-Lift is running. If voltage drops more than 1 volt, the battery is not supplying enough power.
4. If the actuator "free wheels" and does not leak down, the system is low on fluid or has air in system. See "servicing" page 6 for instructions to refill and bleed air.
5. Check the thrust guides. See "adjustments", page 8.
6. If the actuator "free wheels" when the unit is all the way up and then leaks down, replace the actuator.

## PARTS LIST

PART NO.	DESCRIPTION	PART NO.	DESCRIPTION
7050	Actuator	6010	Bottom Actuator Spring Pin
7123	Up-Down Toggle Switch	7312	12V 40A Relay
6045	Position Indicator Gauge	7186	Circuit Breaker
6214	Position Indicator Gauge Sending Unit	6033	1/2" - 13 x 3 Stainless Steel Bolt
7014	Wire Assembly	6035	Stainless Steel 1/2" Hex Nut
20220	Trim Button Switch (optional)	6034	Stainless Steel Flat Washer
6021	Nylatron Thrust Guides	6036	Stainless Steel Lock Washer
6077	P. I. Gauge Conversion Kit	6103	Aluminum Bronze Roller
6009	Top Actuator Spring Pin		

# COOK MANUFACTURING CORPORATION

3920 SOUTH 13TH • DUNCAN, OKLAHOMA 73533

**(580) 252-1699**



## ***LIMITED WARRANTY***

New CMC Power-Lifts® are warranted by the manufacturer for one year from date of purchase against defects in workmanship and/or materials in the hydraulic system and five years from the date of purchase against defects in workmanship and/or material in the structure.

This warranty means that only the parts that prove defective during the period of warranty will be repaired or replaced at our option. Cook Manufacturing Corporation will accept only parts returned for warranty prepaid from initial purchaser and return the repaired or replaced parts freight collect.

Avoid tampering with the Hydraulic Actuator, if a warranty claim is to be made. The warranty is void on any hydraulic actuator returned that shows signs that it has been dismantled or the electrical cordset from the motor has been cut.

A return authorization number must be issued from the factory prior to the return of defective parts. Call toll free in the continental United States 1-800-654-3697; outside the United States Call 580-252-1699 to obtain the return authorization.

There are no warranties which extend beyond the description on the face hereof. No one has authority to make any representations concerning the operation of CMC Power-Lifts® except those made in writing by Cook Manufacturing Corporation.

This warranty does not apply for any racing applications or if damage occurs because of accident, improper handling or operation, abuse or misuse.

All liability for any incidental or consequential damage is expressly excluded herefrom.

In order to obtain the benefit of this warranty and agreement, the warranty card found in the centerfold of this manual must be completely filled out and mailed within 30 days to Cook Manufacturing Corporation.

This warranty applies to original ownership only.